



COMPACTRON DIODE-PENTODE

DESCRIPTION AND RATING

The 38HE7 is a compactron containing a high-perveance diode and a beam-power pentode. The diode is intended for service as the damping diode and the pentode as the horizontal-deflection amplifier in television receivers.

GENERAL

ELECTRICAL

Cathode - Coated Unipotential

Heater Characteristics and Ratings

Heater Voltage, AC or DC*	37.8	Volts
Heater Current†	0.45±0.03	Amperes
Heater Warm-up Time, Average§	11	Seconds
Direct Interelectrode Capacitances, approximate¶			

Diode Section

Cathode to Plate and Heater:			
k to (p + h).	8.0	pf
Plate to Cathode and Heater:			
p to (k + h).	7.0	pf
Heater to Cathode: (h to k).	1.6	pf

Pentode Section

Grid-Number 1 to Plate: (g1 to p).	0.38	pf
Input: g1 to (h + k + g2 + b.p.)	19	pf
Output: p to (h + k + g2 + b.p.)	8.0	pf

MECHANICAL

Operating Position - Any

Envelope - T-12, Glass

Base - E12-74, Button 12-Pin

Outline Drawing - EIA 12-57

Maximum Diameter.	1.563	Inches
Maximum Over-all Length	3.125	Inches
Maximum Seated Height	2.750	Inches

MAXIMUM RATINGS

Design-Maximum ratings are limiting values of operating and environmental conditions applicable to a bogey electron tube of a specified type as defined by its published data and should not be exceeded under the worst probable conditions.

The tube manufacturer chooses these values to provide acceptable serviceability of the tube, making allowance for the effects of changes in operating conditions due to variations in the characteristics of the tube under consideration.

The equipment manufacturer should design so that initially and throughout life no design-maximum value for the intended service is exceeded with a bogey tube under the worst probable operating conditions with respect to supply-voltage variation, equipment component variation, equipment control adjustment, load variation, signal variation, environmental conditions, and variations in the characteristics of all other electron devices in the equipment.

PHYSICAL DIMENSIONS

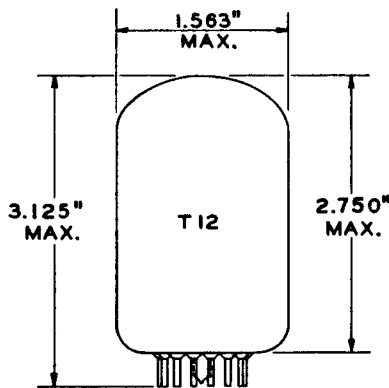

EIA 12-57

TERMINAL CONNECTIONS

- Pin 1 - Heater
- Pin 2 - Diode Plate
- #Pin 3 - No Connection
- Pin 4 - Diode Cathode
- Pin 5 - Pentode Plate
- #Pin 6 - No Connection
- #Pin 7 - Internal Connection
- Pin 8 - Pentode Cathode and Beam Plates
- Pin 9 - Pentode Grid Number 1
- #Pin 10 - Internal Connection
- Pin 11 - Pentode Grid Number 2 (Screen)
- Pin 12 - Heater

BASING DIAGRAM

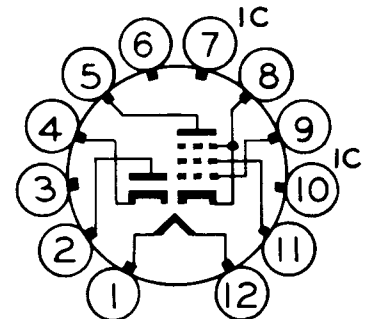

EIA 12FS

MAXIMUM RATINGS (Cont'd)

DESIGN-MAXIMUM VALUES

HORIZONTAL-DEFLECTION AMPLIFIER SERVICE Δ —Pentode Section

DC Plate-Supply Voltage (Boost + DC Power Supply)	500	Volts
Peak Positive Pulse Plate Voltage	5000	Volts
Peak Negative Pulse Plate Voltage	0	Volts
Screen Voltage	150	Volts
Negative DC Grid-Number 1 Voltage	55	Volts
Peak Negative Grid-Number 1 Voltage	330	Volts
Plate Dissipation**	10	Watts
Screen Dissipation	3.5	Watts
Screen Dissipation (With Plate Dissipation Limited to 9 Watts or less)	4.0	Watts
DC Cathode Current	230	Milliamperes
Peak Cathode Current	800	Milliamperes
Heater-Cathode Voltage			
Heater Positive with Respect to Cathode			
DC Component	100	Volts
Total DC and Peak	200	Volts
Heater Negative with Respect to Cathode			
Total DC and Peak	200	Volts
Grid-Number 1 Circuit Resistance	1.0	Megohms

TV DAMPER SERVICE Δ —Diode Section

Peak Inverse Plate Voltage	4200	Volts
Steady-State Peak Plate Current	1200	Milliamperes
DC Output Current	200	Milliamperes
Heater-Cathode Voltage			
Heater Positive with Respect to Cathode			
DC Component	100	Volts
Total DC and Peak	200	Volts
Heater Negative with Respect to Cathode			
DC Component	500	Volts
Total DC and Peak	4200	Volts
Bulb Temperature at Hottest Point	200	C

CHARACTERISTICS AND TYPICAL OPERATION

AVERAGE CHARACTERISTICS

Pentode Section

Plate Voltage	5000	50	130	Volts
Screen Voltage	130	130	130	Volts
Grid-Number 1 Voltage	---	0 $\S\S$	-22	Volts
Plate Resistance, approximate	---	---	6200	Ohms
Transconductance	---	---	8800	Micromhos
Plate Current	---	450	60	Milliamperes
Screen Current	---	40	2.8	Milliamperes
Grid-Number 1 Voltage, approximate					
I _b = 1.0 Milliamperes	-80	---	-39	Volts
Triode Amplification Factor μ_{tr}	---	---	4.2	

Diode Section

Tube Voltage Drop					
I _b = 350 Milliamperes DC			21	Volts

The tubes and arrangements disclosed herein may be covered by patents of General Electric Company or others. Neither the disclosure of any information herein nor the sale of tubes by General Electric Company conveys any license under patent claims covering combinations of tubes with other devices or elements. In the absence of an

express written agreement to the contrary, General Electric Company assumes no liability for patent infringement arising out of any use of the tubes with other devices or elements by any purchaser of tubes or others.

NOTES

- * Heater voltage for a bogey tube at $I_f = 0.45$ amperes.
- ‡ The equipment designer should design the equipment so that heater current is centered at the specified bogey value, with heater supply variations restricted to maintain heater current within the specified tolerance.
- § The time required for the voltage across the heater to reach 80 percent of the bogey value after applying 4 times the bogey heater voltage to a circuit consisting of the tube heater in series with a resistance equal to 3 times the bogey heater voltage divided by the bogey heater current.
- ¶ Without external shield.
- # Socket terminals 3, 6, 7, and 10 should not be used as tie points.
- △ For operation a 525-line, 30-frame television system as described in "Standards of Good Engineering Practice Concerning Television Broadcast Stations", Federal Communications Commission. The duty cycle of the voltage pulse must not exceed 15 percent of one scanning cycle.
- ** In stages operating with grid-leak bias, an adequate cathode-bias resistor or other suitable means is required to protect the tube in the absence of excitation.
- §§ Applied for short interval (two seconds maximum) so as not to damage tube.
- ¶¶ Triode connection (screen tied to plate) with $E_b = E_{c2} = 130$ volts and $E_{c1} = -22$ volts.

AVERAGE PLATE CHARACTERISTICS

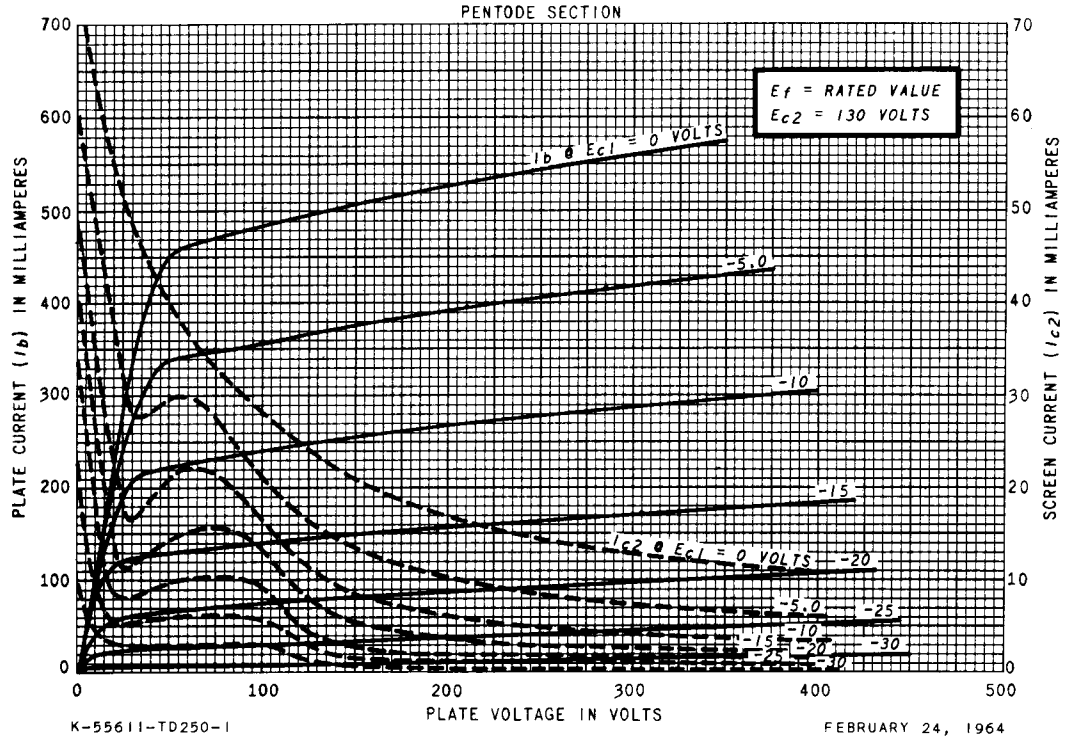

AVERAGE PLATE CHARACTERISTICS

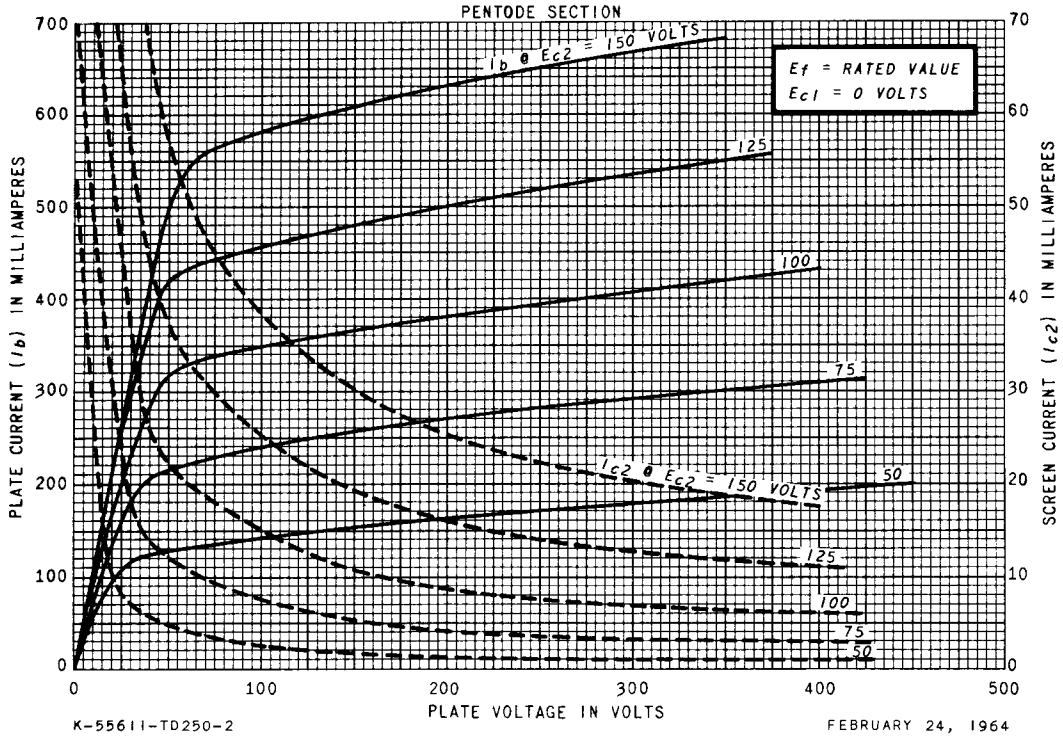

AVERAGE TRANSFER CHARACTERISTICS

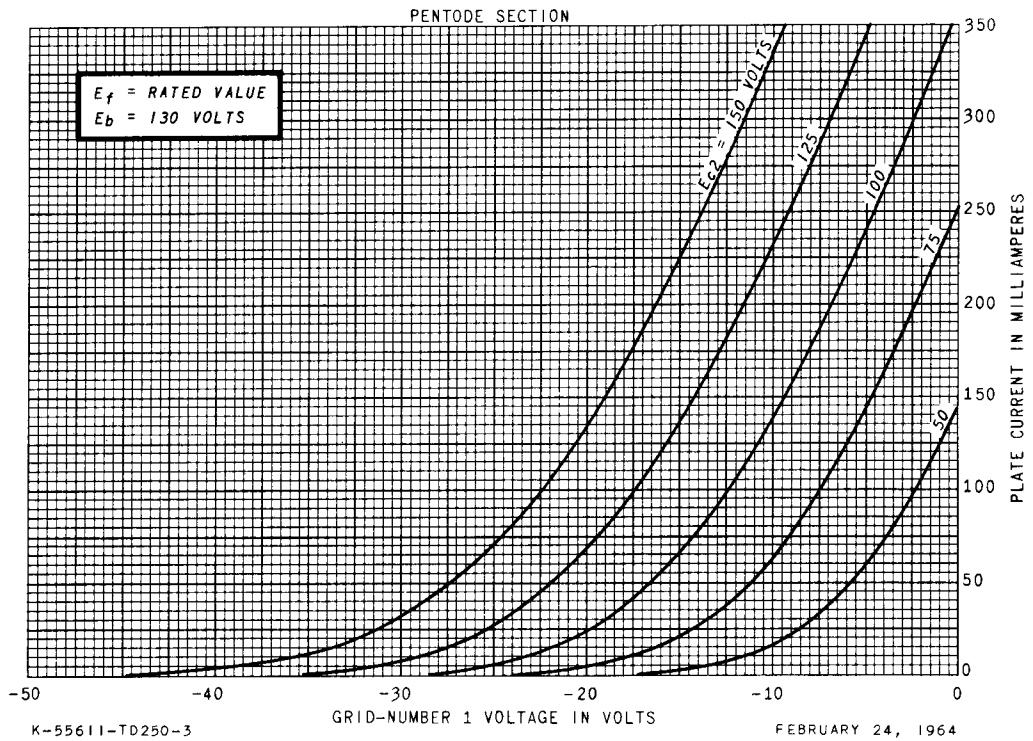

AVERAGE TRANSFER CHARACTERISTICS

PENTODE SECTION

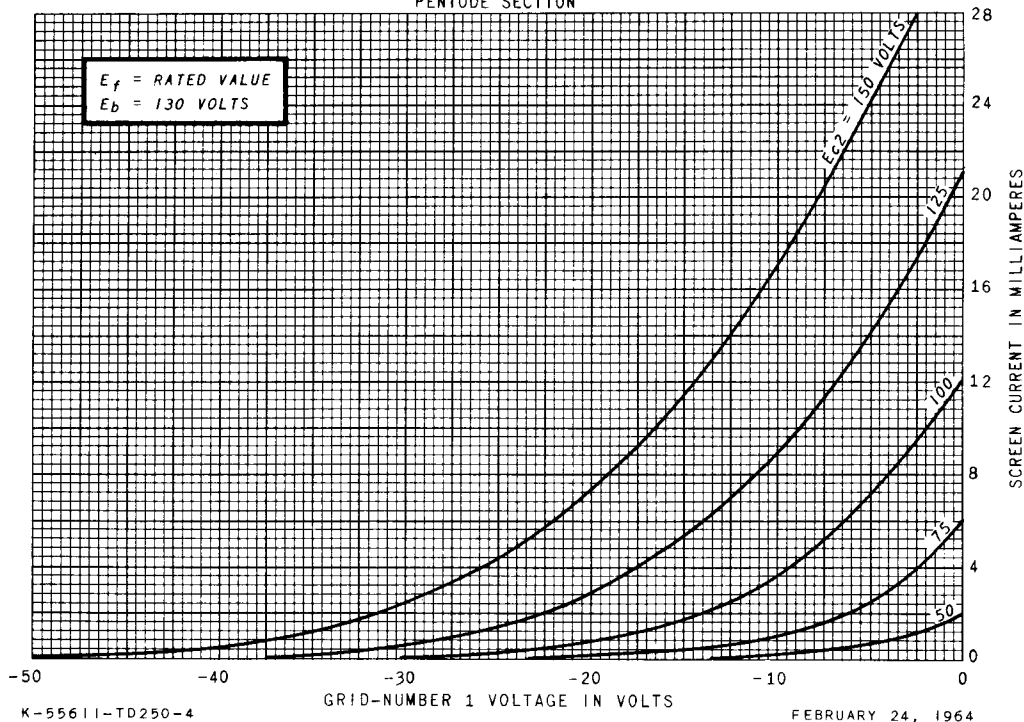

AVERAGE PLATE CHARACTERISTICS

DIODE SECTION

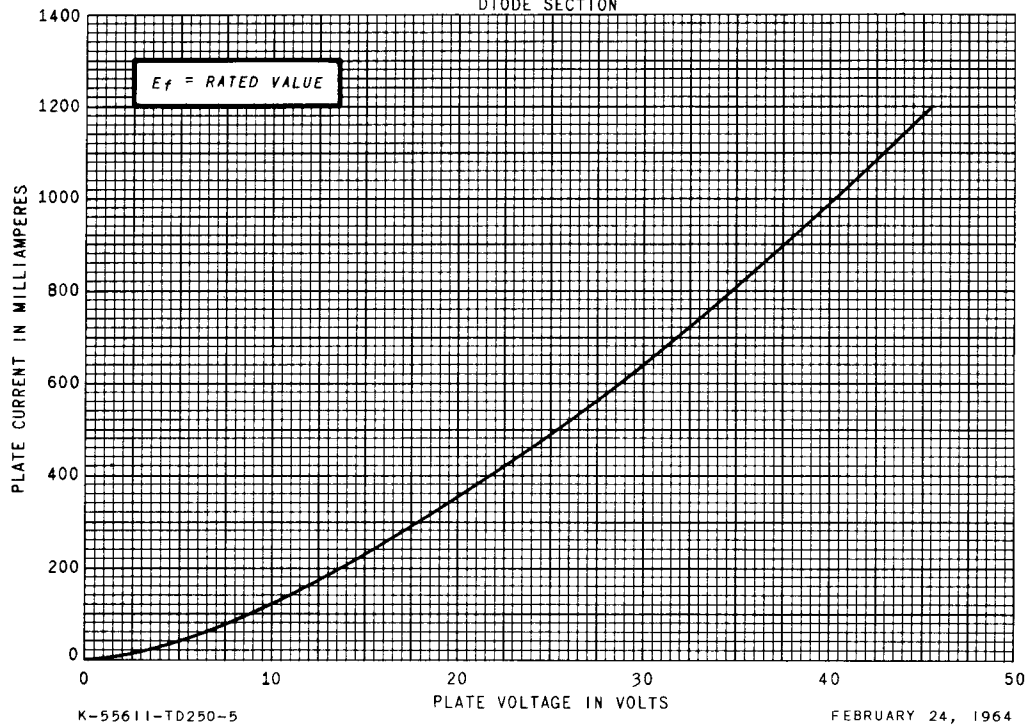

TUBE DEPARTMENT
GENERAL  **ELECTRIC**
Owensboro, Kentucky